



FITTING INSTRUCTIONS FOR CP0417BL
AERO CRASH PROTECTORS FOR KAWASAKI Z1000SX '17- NON-DRILL KIT



Picture A



Picture B

THIS KIT CONTAINS THE ITEMS PICTURED AND LABELLED BELOW.
DO NOT PROCEED UNTIL YOU ARE SURE ALL PARTS ARE PRESENT.

Please note that the way the kit is packed does not necessarily represent the way of mounting to the bike.

THE PARTS SHOWN MAY BE REPRESENTATIVE ONLY (FOR CLARITY OF INSTRUCTIONS ONLY).

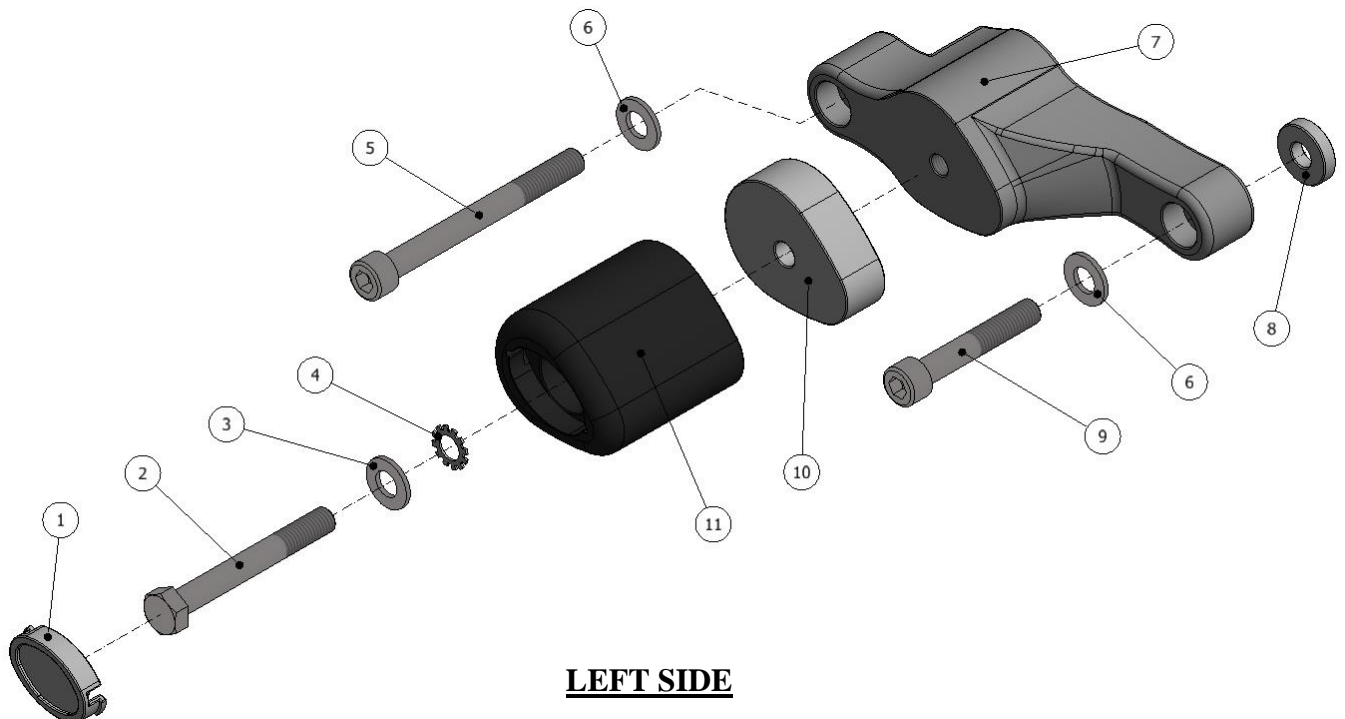

LEFT SIDE

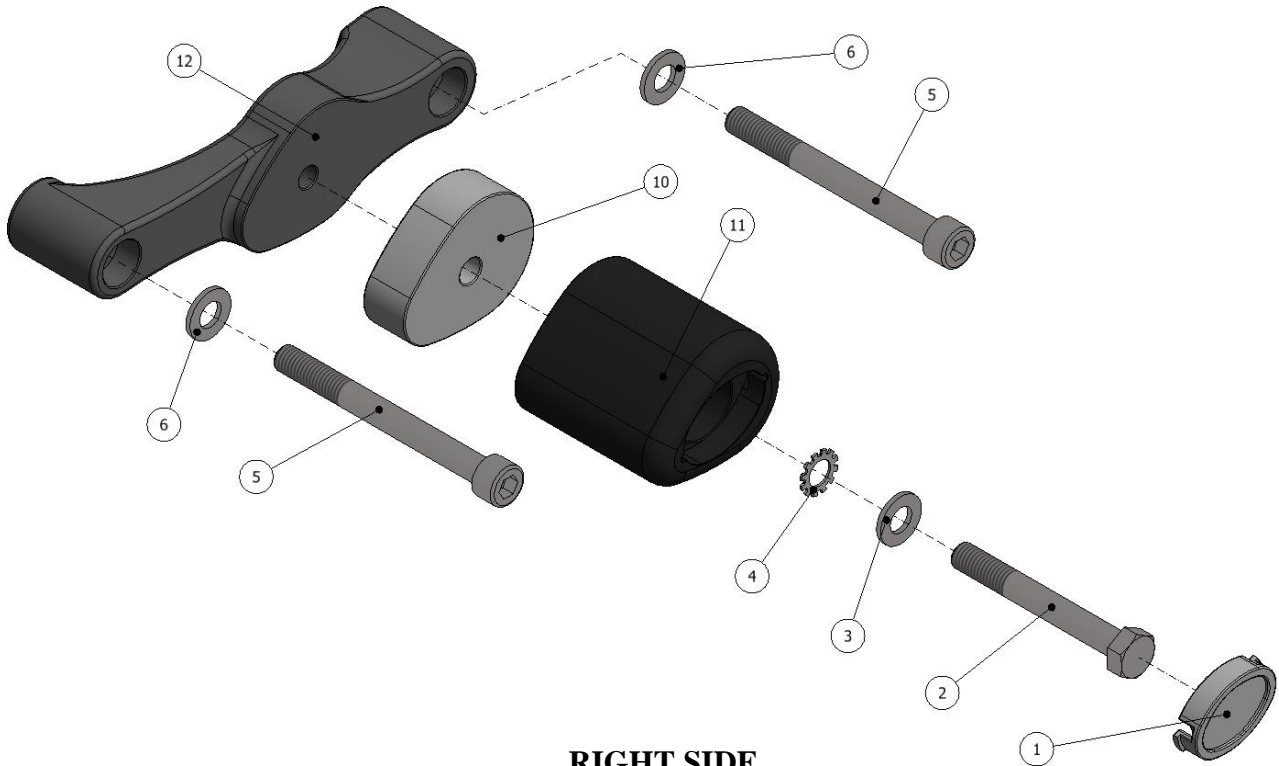

RIGHT SIDE

LEGEND

- ITEM 1 = CRASH PROTECTOR CAPS (BC0002) (x2).
 ITEM 2 = M10 x 1.25 x 80mm LONG HEX HEAD BOLTS (x2).
 ITEM 3 = M10 x 19mm OD WASHERS (x2).
 ITEM 4 = LOCK-WASHERS (LW0001) (x2).
 ITEM 5 = M10 x 1.25 x 100mm LONG CAP HEAD BOLTS (x3).
 ITEM 6 = M10 x 16mm OD WASHERS (x4).
 ITEM 7 = MOUNTING BLOCK LEFT (M0498) (x1).
 ITEM 8 = SPACER (S0253 – 6mm LONG) (x1).
 ITEM 9 = M10 x 1.25 x 60mm LONG CAP HEAD BOLT (x1).
 ITEM 10 = AERO SPACER (S0533 WITH CS438 – 20mm LONG) (x2).
 ITEM 11 = CRASH PROTECTOR (B0061 with CS341) (x2).
 ITEM 12 = MOUNTING BLOCK RIGHT (M0499) (x1).

Please note that in cases where kits are packed with rubber washers holding the components onto the bolt – *the rubber washers should be thrown away!*

TOOLS REQUIRED

- Socket set to include 4, 5, 6 & 8mm AF socket and wrench.
- Socket set to include 15 & 17mm socket and wrench.
 - Small flat headed screwdriver.
 - Torque wrench (up to 40N/m).



TOWARDS REAR
OF BIKE

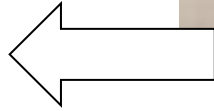

TOWARDS FRONT
OF BIKE

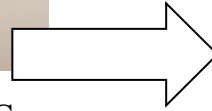

PICTURE C

GENERAL TORQUE SETTINGS

- M4 BOLT = 8Nm
- M5 BOLT = 12Nm
- M6 BOLT = 15Nm
- M8 BOLT = 20Nm
- M10 BOLT = 40Nm



Picture 1



Picture 2



Picture 3



Picture 4



Picture 5



Picture 6



Picture 7



Picture 8

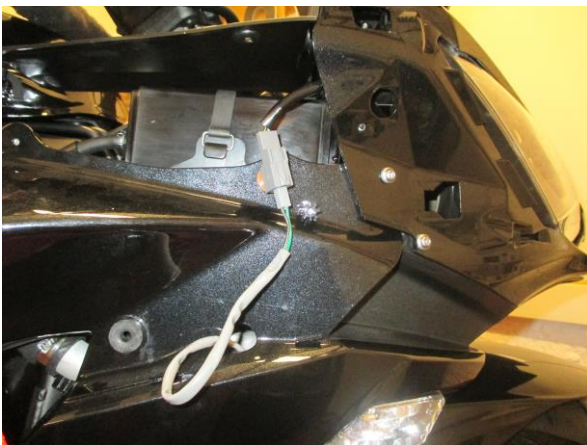

Picture 9

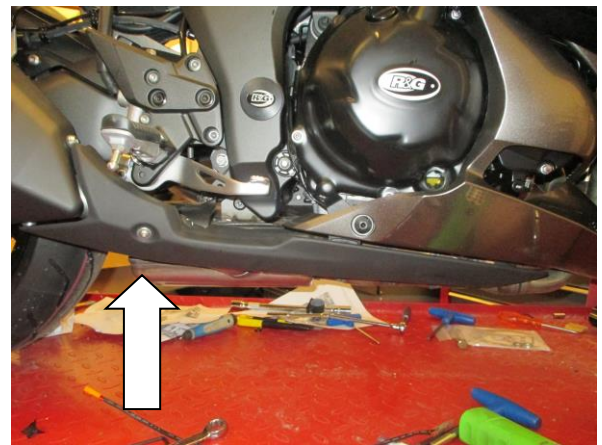

Picture 10

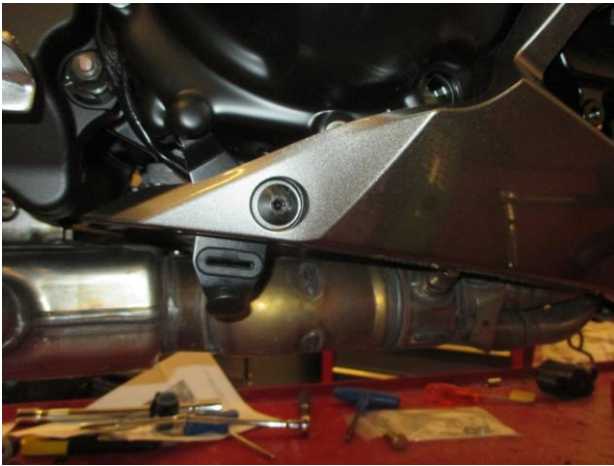

Picture 11



Picture 12

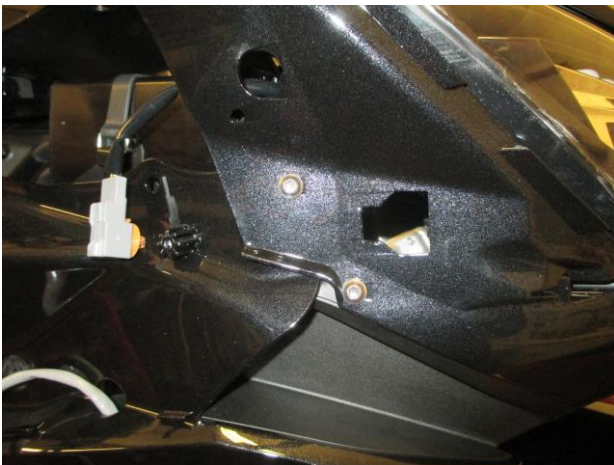

Picture 13



Picture 14



Picture 15

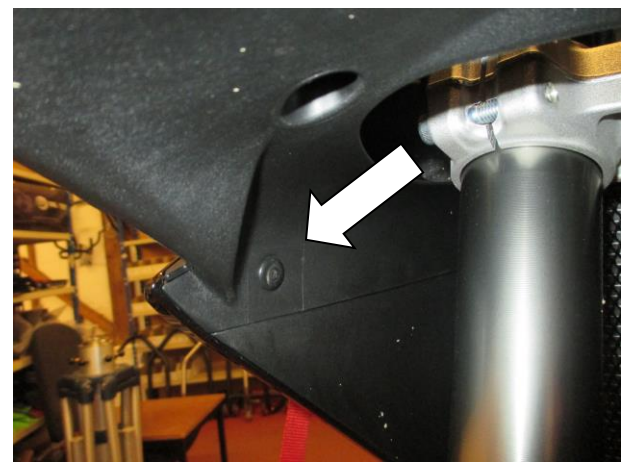

Picture 16

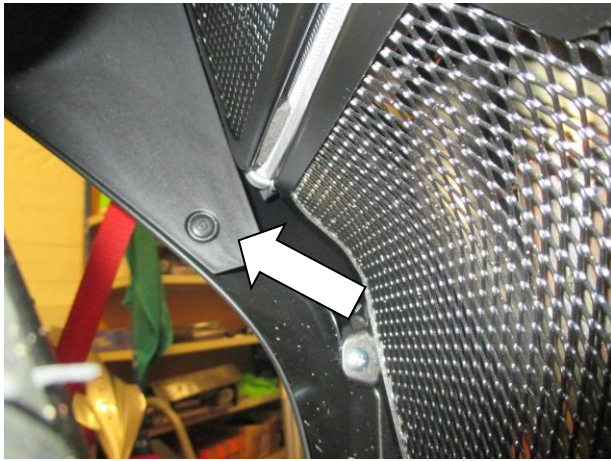

Picture 17

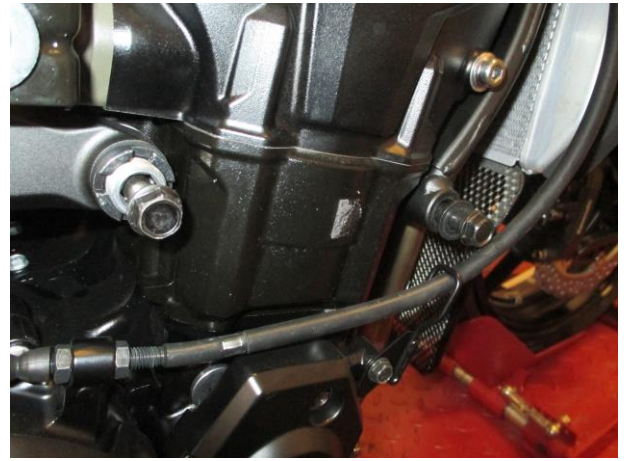

Picture 18

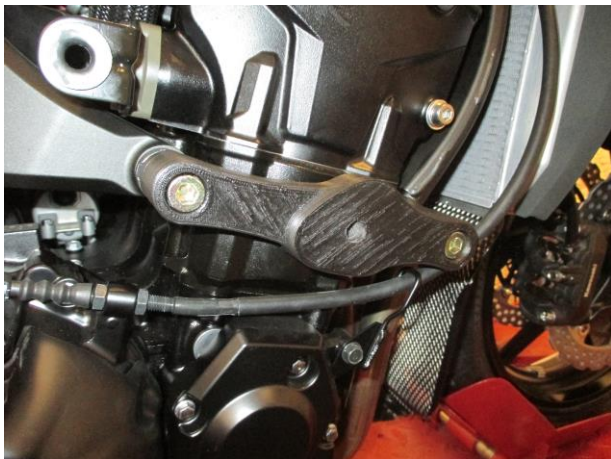

Picture 19

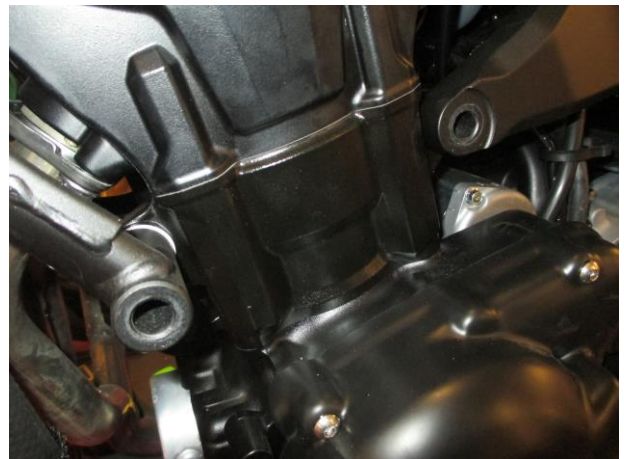

Picture 20



Picture 21



Picture 22



Picture 23



Picture 24

FITTING INSTRUCTIONS

Right side (as you sit on the bike)

- To fit the crash protectors first the fairings must be removed. To do this, start by removing the upper side panel that is arrowed in picture 1. Remove the bolt that is shown in picture 2 and the push rivet that is arrowed in picture 3, before removing from the rubber mount shown in picture 4. The panel should now come away from the bike, as shown in pictures 5 & 6.
- Remove the side infill panel by removing the two bolts that are arrowed in picture 7. The infill panel can now be pulled off its rubber mount and removed from the bike, as shown in picture 8.
- Disconnect the connector for the indicator wiring, as shown in picture 9.
- Remove the metal exhaust shield by removing the bolt that is arrowed in picture 10 and removing from the rubber mount that is shown in picture 11.
- Remove the bolt shown in picture 12, along with the two bolts toward the front that are shown in picture 13 on the main side fairing.
- On the lower belly pan section of the fairing, remove the two push rivets that connect both sides of the fairings together, as shown in pictures 14 & 15.
- On the inside of the side fairings, remove the two push rivets that connect the fairing to the inner radiator cowl plastic, as arrowed in pictures 16 & 17.
- The fairing can now be removed from the bike.
- Remove the two engine/frame bolts on the right side of the bike, as shown in picture 18.
- Take the right side mounting block (item 12 – M0499) and locate two M10 x 1.25 x 100mm long cap head bolts (item 5) and two M10 x 16mm OD washers (item 6) through the two holes on the block, ensuring the washers and the bolt heads sit within the two recesses, as shown in the exploded diagram on page 2.
- Offer this assembly up to the bike, ensuring the boss for the bobbin is correctly orientated facing forwards, as shown in picture 19, before loosely tightening both bolts.
- Ensure the block is correctly fitted, before fully tightening both bolts. Do not over tighten as damage can occur to the bike. Do not exceed 40N/m of torque.

Left side (as you sit on the bike)

- To fit the crash protectors on the left side of the bike, the fairings need to be removed using the same procedure as used on the right side fairings.
- Remove the upper side panel by removing the bolt and push rivet before removing from the rubber mount. The panel should now come away from the bike.



- Remove the side infill panel by removing the two bolts and then the infill panel can be pulled off its rubber mount and removed from the bike.
- Disconnect the connector for the indicator wiring.
- Remove the three bolts on the main side fairing and on the inside of the side fairing, remove the two push rivets that connect the fairing to the inner radiator cowl plastic, before removing the fairing from the bike.
- Remove the two engine/frame bolts on the left side of the bike, as shown in picture 20.
- Take the left side mounting block (item 7 – M0498) and locate the remaining M10 x 1.25 x 100mm long cap head bolt (item 5) and one M10 x 16mm OD washer (item 6) through the forward, thicker hole on the block, ensuring the washer and the bolt head sit within the recess, as shown in the exploded diagram on page 1.
- Locate the M10 x 1.25 x 60mm long cap head bolt (item 9) and the remaining M10 x 16mm OD washer (item 6) through the remaining rearward hole on the block, ensuring the washer and the bolt head sit within the recess, as shown in the exploded diagram on page 1. Position the spacer (item 8 – S0253 – 6mm long) over the exposed thread on the shorter bolt, so that it sits between the block and frame when fitted.
- Offer this assembly up to the bike, ensuring the boss for the bobbin is correctly orientated facing forwards, as shown in pictures 21 & 22, before loosely tightening both bolts.
- Ensure the block is correctly fitted, before fully tightening both bolts. Do not over tighten as damage can occur to the bike. Do not exceed 40N/m of torque.

- With the two blocks fitted, both fairings can now be re-fitted to the bike in the reverse procedure to how they were removed. *Ensure the connectors for both indicators are re-connected.*
- With the fairings fitted the crash protectors can now be fitted.
- To fit the left side crash protector, slide one of the 10mm washers (item 3) onto one of the M10 x 80mm long hex head bolts (item 2) so the washer sits against head of bolt.
- Slide one serrated locking washer (item 4) over the bolt so it sits against the washer just fitted.
- Next slide the bolt with washers through either crash protector (item 11) so the head of the bolt and washers go into the counter-bore.
- Slide one of the aero profile spacers (item 10 – S0533 with CS438 – 20mm long) onto the end of the bolt and offer this assembly up to the mounting block already fitted on to the bike, as shown in picture 23.
- Tighten the crash protector bolt until you feel some compression from inside the protector using a 17mm socket and wrench. **PLEASE NOTE THE CRASH PROTECTOR MUST BE POSITIONED AS IN PICTURE ‘C’ WITH BIGGER END TOWARD FRONT OF BIKE.** Turn a little more so that you feel the compression increase slightly. Then apply a quarter turn. Do not over tighten as damage can occur to the bike. Do not exceed 40N/m of torque.
- To fit the right side crash protector, slide one of the 10mm washers (item 3) onto one of the M10 x 80mm long hex head bolts (item 2) so the washer sits against head of bolt.
- Slide one serrated locking washer (item 4) over the bolt so it sits against the washer just fitted.
- Next slide the bolt with washers through either crash protector (item 11) so the head of the bolt and washers go into the counter-bore.
- Slide one of the aero profile spacers (item 10 – S0533 with CS438 – 20mm long) onto the end of the bolt and offer this assembly up to the mounting block already fitted on to the bike, as shown in picture 24.
- Tighten the crash protector bolt until you feel some compression from inside the protector using a 17mm socket and wrench. **PLEASE NOTE THE CRASH PROTECTOR MUST BE POSITIONED AS IN PICTURE ‘C’ WITH BIGGER END TOWARD FRONT OF BIKE.** Turn a little more so that you feel the compression increase slightly. Then apply a quarter turn. Do not over tighten as damage can occur to the bike. Do not exceed 40N/m of torque.
- If not already fitted fit bubble stickers into recess of both crash protector caps.
- Fit crash protector caps into both crash protectors.

ISSUE 2 20/07/2021 (AO)

R&G Racing

Unit 1, Shelley's Lane, East Worldham, Alton, Hampshire, GU34 3AQ

Tel: +44 (0)1420 89007 Fax: +44 (0)1420 87301 www.rg-racing.com Email: info@rg-racing.com



Digital copies of these instructions are available to download from www.rg-racing.com

CONSUMER NOTICE

The catalogue description and any exhibition of samples are only broad indications of the Products and R&G may make design changes which do not diminish their performance or visual appeal and supplying them in such state shall conform to the order. The Buyer acknowledges no representation or warranty (other than as to title) has been given or will apply to the Products other than those in R&G's order or confirmation and the Buyer confirms it has chosen the Products as being of merchantable quality and suitable for its particular purposes. Where R&G fits the Products or undertakes other services it shall exercise reasonable skill and care and rectify any fault free of charge unless the workmanship has been disturbed. The Buyer is responsible for ensuring that the warranty on the motorcycle is not affected by the fitting of the Products. On return of any defective Products R&G shall at its option either supply a replacement or refund the purchase money but shall not be liable if the Products have been modified or used or maintained otherwise than in accordance with R&G's or manufacturer's instructions and good engineering practice or if the defect arises from accident or neglect. Other than identified above and subject to R&G not limiting its liability for causing death and personal injury, it shall not be liable for indirect or consequential loss and otherwise its liability shall be limited to the amounts paid by the Buyer for the Products or the fitting or service concerned. These terms do not affect the Buyer's statutory rights.

R&G RACING RETURNS POLICY (NON-FAULTY GOODS)

Returns must be pre-authorized (if not pre-authorized the return will be rejected). Goods may only be returned direct to us if they were purchased direct from us (customer must prove if necessary). Otherwise to be returned to original vendor. Goods must be in re-sellable condition, in the opinion of R&G Racing. All returns are subject to a 25% restocking and handling fee (25% of the gross value exc. P&P – at the prevailing price at time of purchase). The customer must pay any and all carriage charges. No returns of discontinued products, unless within 14 days of purchase. This policy does not affect your statutory rights and does not refer to faulty goods.



NOTICE DE MONTAGE POUR CP0417BL
PROTECTIONS CRASH POUR KAWASAKI Z1000SX '17- KIT NON PERCE



Photo A

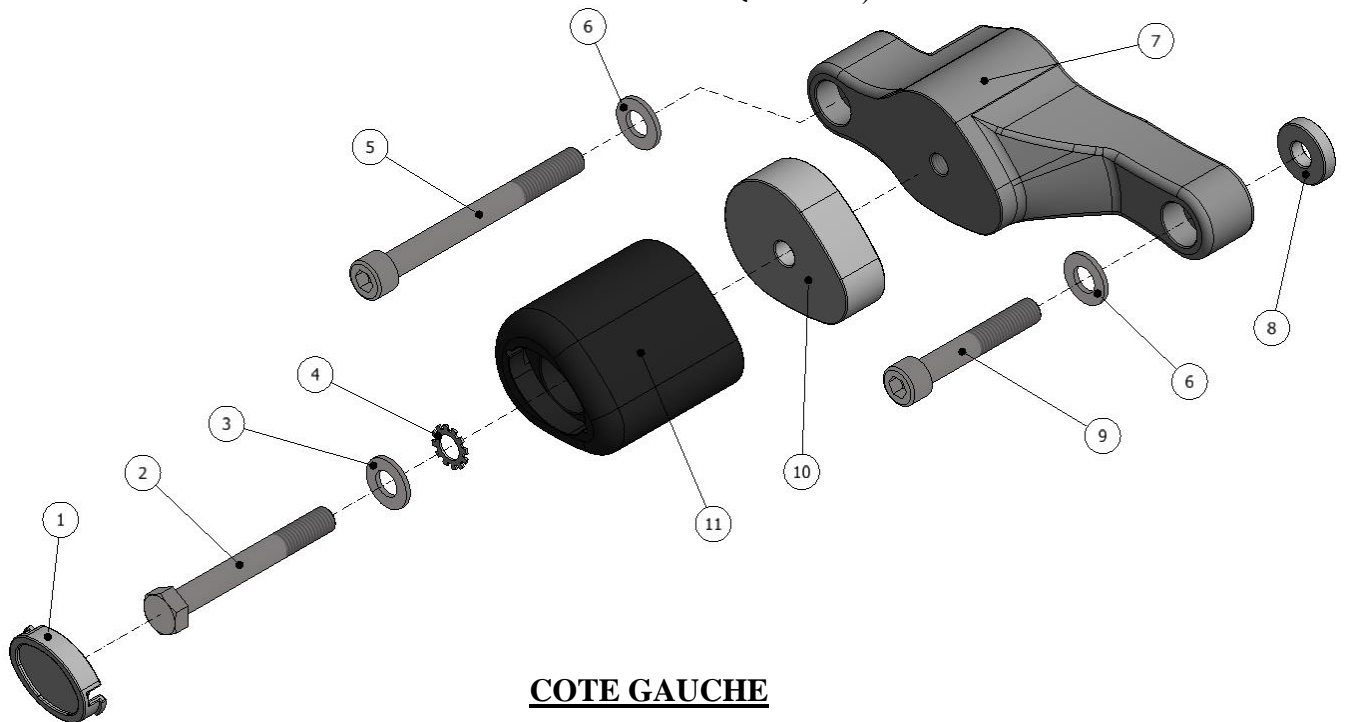

Photo B

LE KIT CONTIENT LES ARTICLES EXPOSES CI-DESSOUS, VERIFIER QUE TOUTES LES PIECES SOIENT PRESENTES AVANT DE PROCEDER AU MONTAGE.

La façon dont le kit est emballé ne correspond pas forcément à la façon de monter les pièces sur la moto.

LES PARTIES PRESENTEES PEUVENT ETRE UNIQUEMENT REPRESENTATIVES (POUR LA CLARTE DES INSTRUCTIONS UNIQUEMENT).



COTE GAUCHE

R&G Racing

Unit 1, Shelley's Lane, East Worldham, Alton, Hampshire, GU34 3AQ

Tel: +44 (0)1420 89007 Fax: +44 (0)1420 87301 www.rg-racing.com Email: info@rg-racing.com

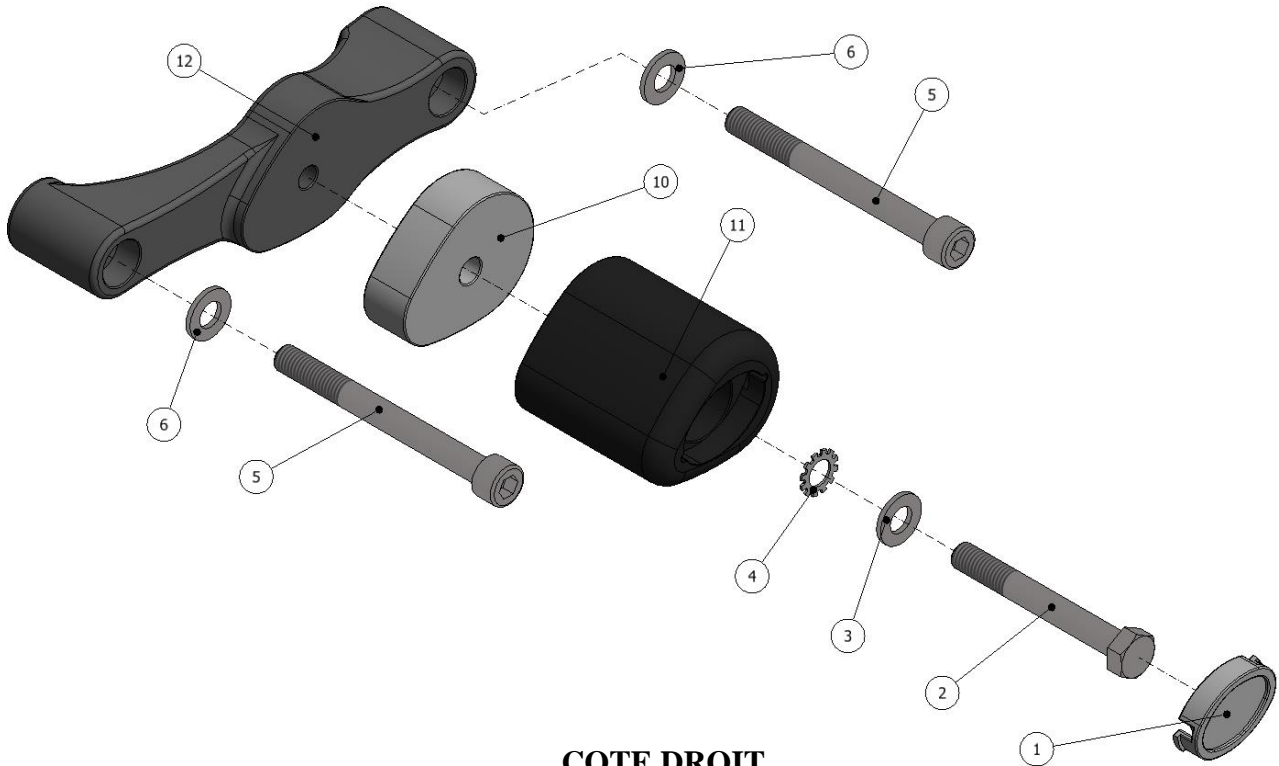

COTE DROIT

LEGENDE

- ARTICLE 1 = CAPUCHONS DE PROTECTION CRASH (BC0002) (x2).
 ARTICLE 2 = M10 x 1.25 x 80mm BOULONS (x2).
 ARTICLE 3 = M10 x 19mm RONDELLES (x2).
 ARTICLE 4 = RONDELLES DE BLOCAGE (LW0001) (x2).
 ARTICLE 5 = M10 x 1.25 x 100mm BOULONS (x3).
 ARTICLE 6 = M10 x 16mm RONDELLES (x4).
 ARTICLE 7 = BLOC DE MONTAGE COTE GAUCHE (M0498) (x1).
 ARTICLE 8 = ENTRETOISE (S0253 – 6mm DE LONG) (x1).
 ARTICLE 9 = M10 x 1.25 x 60mm BOULON (x1).
 ARTICLE 10 = ENTRETOISE (S0533 avec CS438 – 20mm DE LONG) (x2).
 ARTICLE 11 = PROTECTION CRASH (B0061 avec CS341) (x2).
 ARTICLE 12 = BLOC DE MONTAGE COTE DROIT (M0499) (x1).

Notez que si les kits sont emballés avec des rondelles en caoutchouc servant à tenir les composants, *ces rondelles doivent être jetées!*

OUTILS REQUIS

- Clé à cliquet + douille 4, 5, 6 & 8mm.
- Clé à cliquet + douille 15 & 17mm.
 - Petit tournevis plat.
- Clé dynamométrique (à 40Nm).



ARRIÈRE MOTO

AVANT MOTO

PHOTO 'C'

COUPLES DE SERRAGE RECOMMANDES

- M4 BOULON = 8Nm
- M5 BOULON = 12Nm
- M6 BOULON = 15Nm
- M8 BOULON = 20Nm
- M10 BOULON = 40Nm



Photo 1



Photo 2



Photo 3



Photo 4



Photo 5



Photo 6



Photo 7



Photo 8



Photo 9

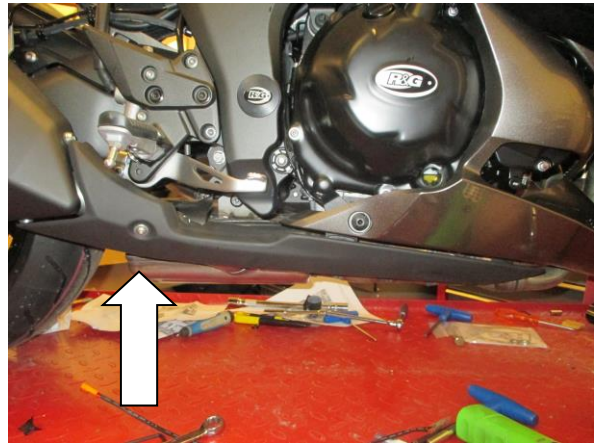

Photo 10



Photo 11



Photo 12



Photo 13



Photo 14



Photo 15

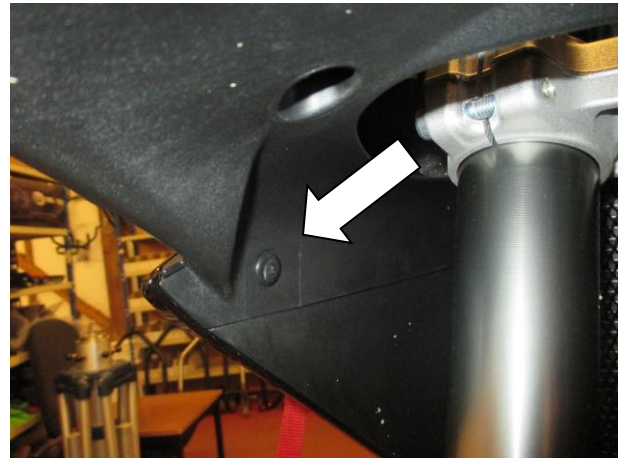

Photo 16

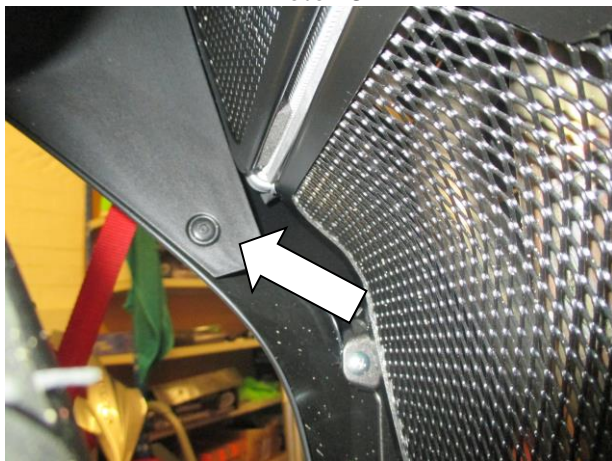

Photo 17

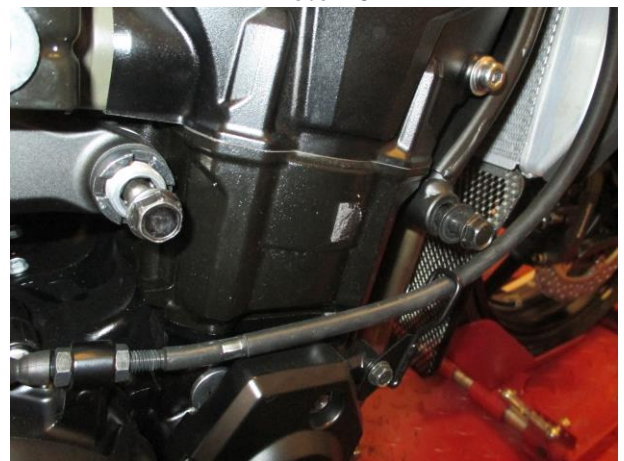

Photo 18

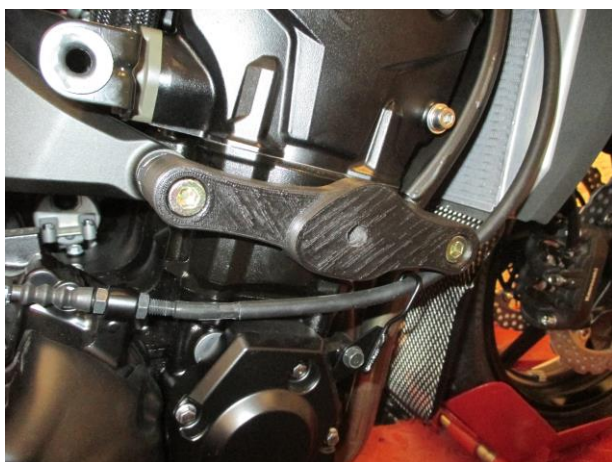

Photo 19



Photo 20



Photo 21



Photo 22



Photo 23



Photo 24

NOTICE DE MONTAGE:

Coté droit (assis sur la moto)

- Pour monter les protections crash, commencez par enlever les carénages. Pour cela, commencer par enlever le panneau supérieur latéral indiqué sur la photo 1. Enlever le boulon indiqué sur la photo 2 et le rivet indiqué sur la photo 3, avant de l'enlever du support en caoutchouc, voir photo 4. Le panneau doit à présent s'extraire de la moto, voir photos 5 & 6.
- Enlever le panneau interne en enlevant les 2 boulons indiqués sur la photo 7. Le panneau interne peut maintenant être retiré de son support en caoutchouc et de la moto, voir photo 8.
- Déconnecter le connecteur des fils de clignotant, voir photo 9.
- Enlever le bouchon d'échappement métallique en enlevant le boulon indiqué sur la photo 10 et enlevez le de son support de caoutchouc, voir photo 11.
- Enlever le boulon indiqué sur la photo 12, avec les 2 boulons vers l'avant comme cela est visible sur la photo 13 sur le carénage latéral principal.
- Sur le bas du ventre du carénage, enlever les 2 rivets qui connectent les 2 cotés des carénages ensemble, voir photos 14 & 15.



- A l'intérieur des carénages latéraux, enlever les 2 rivets qui connectent le carénage à l'intérieur du capot du radiateur en plastique, voir photos 16 & 17.
- Le carénage peut maintenant être enlevé de la moto.
- Enlever les 2 boulons moteur/cadre du côté droit de la moto, voir photo 18.
- Prendre le bloc de montage du côté droit (article 12 – M0499) et insérer 2 boulons M10 x 1.25 x 100mm (article 5) et 2 rondelles M10 x 16mm (article 6) dans les 2 trous du bloc, en veillant à ce que les rondelles et les têtes de boulons se placent dans les 2 creux, voir schéma sur la page 2.
- Monter l'ensemble sur la moto, en veillant à ce que le trou pour la bobine soit correctement orienté vers l'avant, voir photo 19, avant de serrer légèrement les 2 boulons.
- Veiller à ce que le bloc soit correctement monté, avant de serrer complètement les 2 boulons. Ne pas bloquer pour le moment. Ne pas excéder 40N/m de couple.

Coté gauche (assis sur la moto)

- Pour monter les protections crash du côté gauche de la moto, commencez par enlever les carénages en procédant de la même façon que pour les carénages du côté droit.
- Enlever le panneau interne supérieur en enlevant le boulon et le rivet avant de l'enlever du support en caoutchouc. Le panneau peut maintenant être retiré de la moto.
- Enlever le panneau interne en enlevant les 2 boulons. Le panneau interne peut maintenant être retiré de son support en caoutchouc et de la moto.
- Déconnecter le connecteur des fils de clignotant.
- Enlever les 3 boulons situés sur le carénage principal et à l'intérieur du carénage latéral, enlever les 2 rivets qui connectent le carénage à l'intérieur du capot du radiateur en plastique, avant d'enlever le carénage de la moto.
- Enlever les 2 boulons moteur/cadre du côté gauche de la moto, voir photo 20.
- Prendre le bloc de montage du côté gauche (article 7 – M0498) et insérer le boulon restant M10 x 1.25 x 100mm (article 5) et une rondelle M10 x 16mm (article 6) dans le trou plus épais situé le plus à l'avant du bloc, en veillant à ce que la rondelle et la tête du boulon se place dans le creux, voir le schéma situé en page 1.
- Placer le boulon M10 x 1.25 x 60mm (article 9) et la rondelle M10 x 16mm (article 6) dans le trou restant le plus reculé du bloc, en veillant à ce que la rondelle et la tête du boulon se place dans le creux, voir le schéma en page 1. Positionner l'entretoise (article 8 – S0253 – 6mm de long) sur le filetage du boulon le plus court, de façon à ce qu'elle se place entre le bloc et le cadre.
- Monter l'ensemble sur la moto, en veillant à ce que le trou pour la bobine soit correctement orienté vers l'avant, voir photos 21 & 22, avant de serrer les 2 boulons.
- Prendre le bloc de montage du côté droit (article 12 – M0499) et insérer 2 boulons M10 x 1.25 x 100mm (article 5) et 2 rondelles M10 x 16mm (article 6) dans les 2 trous du bloc, en veillant à ce que les rondelles et les têtes de boulons se placent dans les 2 creux, voir schéma sur la page 2.
- Monter l'ensemble sur la moto, en veillant à ce que le trou pour la bobine soit correctement orienté vers l'avant, voir photo 19, avant de serrer légèrement les 2 boulons.
- Veiller à ce que le bloc soit correctement monté, avant de serrer complètement les 2 boulons. Ne pas bloquer pour le moment. Ne pas excéder 40N/m de couple.
- Une fois les 2 blocs montés, les 2 carénages peuvent être remontés sur la moto dans le processus inverse de la façon dont ils ont été enlevés. *Veiller à ce que les connecteurs des 2 clignotants soient reconnectés.*
- Une fois les carénages montés, les protections crash peuvent être installés.
- Pour monter la protection crash du côté gauche, glisser une des rondelles 10mm (article 3) sur un des boulons M10 x 80mm (article 2) de façon à ce que la rondelle se place contre la tête du boulon.



- Glisser une rondelle de blocage crantée (article 4) sur le boulon de façon à ce qu'elle se place contre la rondelle tout juste insérée.
- Ensuite, insérer le boulon avec ses rondelles dans la protection crash (article 11) de façon à ce que la tête du boulon et les rondelles se placent dans le contre alésage.
- Glisser une des entretoises (article 10 – S0533 avec CS438 – 20mm de long) sur l'extrémité du boulon puis monter l'ensemble sur le bloc de montage déjà monté sur la moto, voir photo 23.
- Serrer le boulon de la protection crash jusqu'à ce que vous sentiez une légère compression de l'intérieur de la protection avec une clé de 17m. **LA PROTECTION DOIT ETRE POSITIONNEE COMME EN "C" AVEC LE COTE ARRONDI LE PLUS GROS EN DIRECTION DE L'AVANT DE LA MOTO.** Tourner un peu plus afin d'accentuer légèrement la compression. Appliquer un quart de tour Serrer à 40Nm de couple (ne pas excéder cette valeur, car cela pourrait endommager la moto et le boulon).
- Pour monter la protection crash du coté droit, glisser une des rondelles 10mm (article 3) sur un des boulons M10 x 80mm (article 2) de façon à ce que la rondelle se place contre la tête du boulon.
- Glisser une rondelle de blocage (article 4) sur le boulon de façon à ce qu'elle se place contre la rondelle tout juste insérée.
- Glisser ensuite le boulon avec ses rondelles dans la protection crash (article 11) de façon à ce que la tête du boulon et les rondelles se placent dans le contre alésage.
- Glisser une des entretoises (article 10 – S0533 avec CS438 – 20mm de long) sur l'extrémité du boulon et monter l'ensemble sur le bloc de montage déjà monté sur la moto, voir photo 24.
- Serrer le boulon de la protection crash jusqu'à ce que vous sentiez une légère compression de l'intérieur de la protection avec une clé de 17m. **LA PROTECTION DOIT ETRE POSITIONNEE COMME EN "C" AVEC LE COTE ARRONDI LE PLUS GROS EN DIRECTION DE L'AVANT DE LA MOTO.** Tourner un peu plus afin d'accentuer légèrement la compression. Appliquer un quart de tour Serrer à 40Nm de couple (ne pas excéder cette valeur, car cela pourrait endommager la moto et le boulon).
- Placer le logo en caoutchouc dans le creux des 2 protections.
- Mettre les capuchons de protections crash dans les 2 protections crash.

ISSUE 2 20/07/2021 (AO)

Notice disponible au téléchargement sur www.rg-racing.com

CONSUMER NOTICE

The catalogue description and any exhibition of samples are only broad indications of the Products and R&G may make design changes which do not diminish their performance or visual appeal and supplying them in such state shall conform to the order. The Buyer acknowledges no representation or warranty (other than as to title) has been given or will apply to the Products other than those in R&G's order or confirmation and the Buyer confirms it has chosen the Products as being of merchantable quality and suitable for its particular purposes. Where R&G fits the Products or undertakes other services it shall exercise reasonable skill and care and rectify any fault free of charge unless the workmanship has been disturbed. The Buyer is responsible for ensuring that the warranty on the motorcycle is not affected by the fitting of the Products. On return of any defective Products R&G shall at its option either supply a replacement or refund the purchase money but shall not be liable if the Products have been modified or used or maintained otherwise than in accordance with R&G's or manufacturer's instructions and good engineering practice or if the defect arises from accident or neglect. Other than identified above and subject to R&G not limiting its liability for causing death and personal injury, it shall not be liable for indirect or consequential loss and otherwise its liability shall be limited to the amounts paid by the Buyer for the Products or the fitting or service concerned. These terms do not affect the Buyer's statutory rights.

R&G RACING RETURNS POLICY (NON-FAULTY GOODS)

Returns must be pre-authorized (if not pre-authorized the return will be rejected). Goods may only be returned direct to us if they were purchased direct from us (customer must prove if necessary). Otherwise to be returned to original vendor. Goods must be in re-sellable condition, in the opinion of R&G Racing. All returns are subject to a 25% restocking and handling fee (25% of the gross value exc. P&P – at the prevailing price at time of purchase). The customer must pay any and all carriage charges. No returns of discontinued products, unless within 14 days of purchase. This policy does not affect your statutory rights and does not refer to faulty goods.

R&G Racing

Unit 1, Shelley's Lane, East Worldham, Alton, Hampshire, GU34 3AQ

Tel: +44 (0)1420 89007 Fax: +44 (0)1420 87301 www.rg-racing.com Email: info@rg-racing.com