

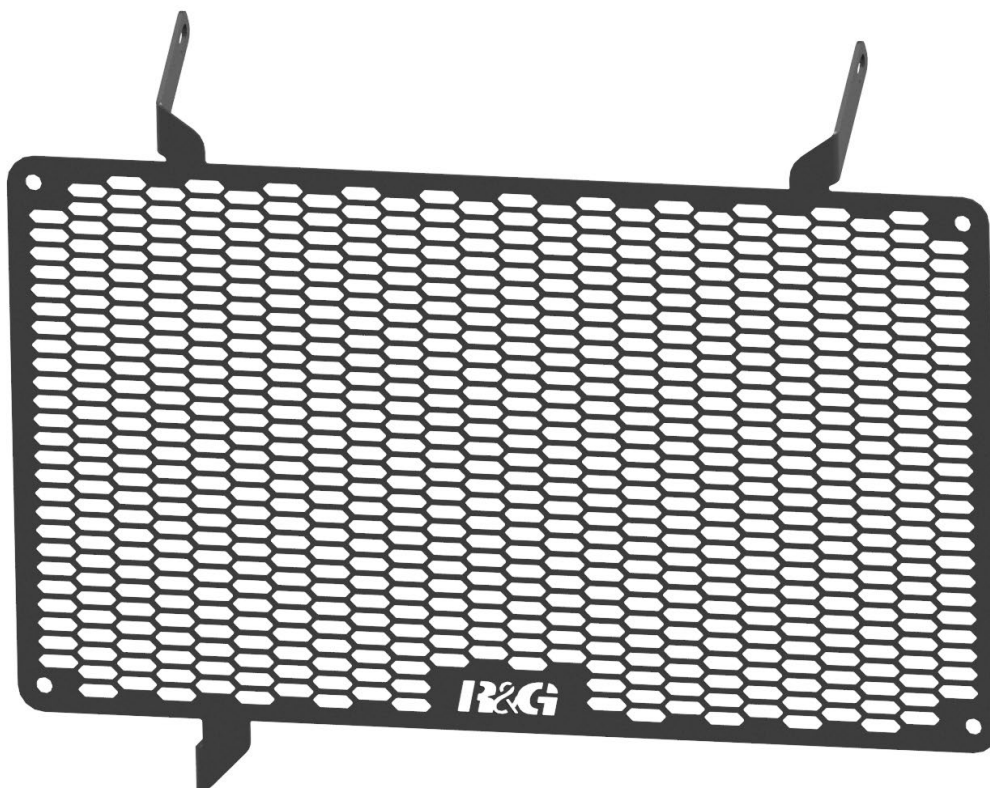

FITTING INSTRUCTIONS FOR RAD0360PRO



THIS KIT CONTAINS THE ITEMS PICTURED AND LABELLED OVER PAGE.

SOME PARTS MAY BE SHOWN FOR CLARITY OF INSTRUCTIONS ONLY.

DO NOT PROCEED UNTIL YOU ARE SURE ALL PARTS ARE PRESENT.

PLEASE READ ALL INSTRUCTIONS BEFORE PROCEEDING.

**IF IN ANY DOUBT WHEN FITTING OUR PRODUCTS, CONSULT ONE OF OUR DEALERS
OR HAVE FITTED BY A QUALIFIED TECHNICIAN.**

PLEASE NOTE THAT THE WAY THE KIT IS PACKED DOES NOT NECESSARILY REPRESENT THE WAY OF
MOUNTING TO THE BIKE.

IN THE EVENT OF RUBBER WASHERS BEING USED TO HOLD COMPONENTS ONTO BOLTS,
THESE RUBBER WASHERS CAN BE THROWN AWAY.

DIGITAL COPIES OF THESE INSTRUCTIONS ARE AVAILABLE FROM:

WWW.RG-RACING.COM



<u>TOOLS REQUIRED</u>	<u>GENERAL TORQUE SETTINGS</u>
<ul style="list-style-type: none"> 8mm & 10mm SPANNER 	<p>M4 BOLT = 8Nm M5 BOLT = 12Nm M6 BOLT = 15Nm M8 BOLT = 20Nm M10 BOLT = 40Nm M12 BOLT = 40Nm</p>

LEGEND

ITEM NO.	DESCRIPTION	QTY
ITEM 1	RAD0360PRO (ALUMINIUM RADIATOR GUARD)	1
ITEM 2	RB0015 (RUBBER GROMMETS)	4

FITTING DIAGRAM

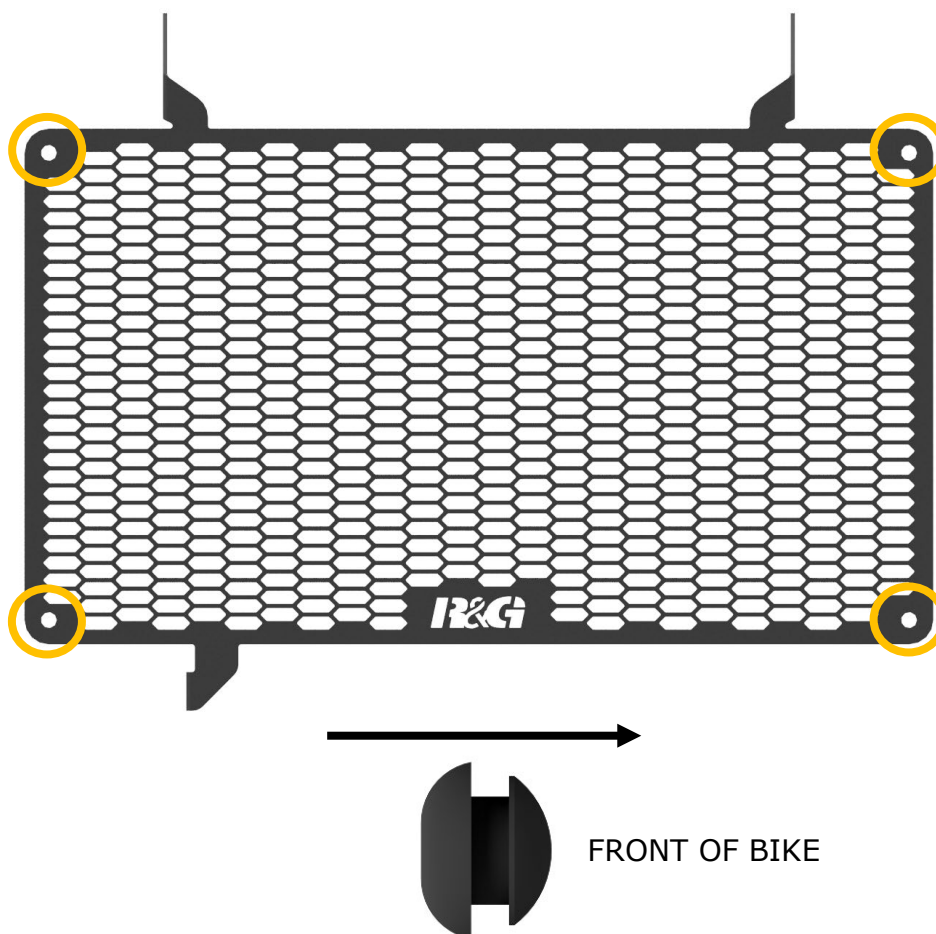



FITTING PICTURES

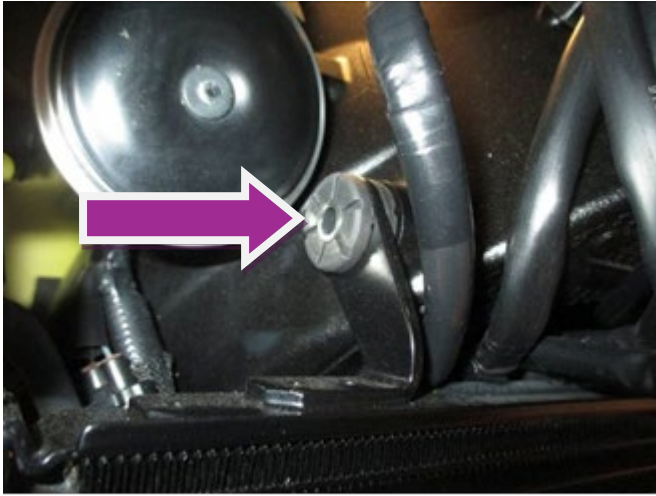

Picture 1

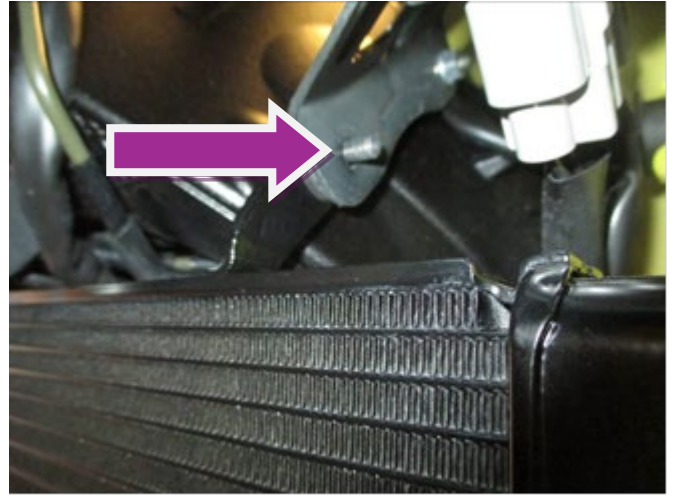

Picture 2

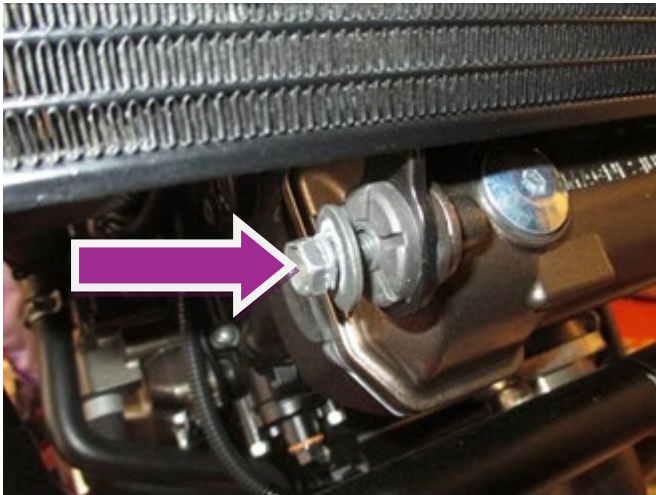

Picture 3

FITTING INSTRUCTIONS

- Insert the 4x rubber grommets (**Item 2**) into the radiator guard in the holes circled in yellow (as shown above) if they do not come already installed.
- Remove the upper radiator mounting bolt as shown in **Picture 1**.
- Remove the nut on the outside of the radiator mount as shown in **Picture 2**.
- Offer the radiator guard (**Item 1**) into position ensuring the LHS mount hooks over the mounting thread, and the RHS upper mount lines up with the radiator mount.
- Replace the nut from the LHS radiator mount.
- Replace the bolt removed from the RHS mount ensuring to place through the radiator guard mount, do not fully tighten at this stage.
- Remove the lower radiator mount bolt as shown in **Picture 3** and rotate the radiator guard into position, lining the lower radiator guard mount hole up with the lower mount.
- Once you are happy with the position of the radiator guard, tighten each bolt until the guard is firmly secured into position.

R&G Racing

Unit 1, Shelley's Lane, East Worldham, Alton, Hampshire, GU34 3AQ

Tel: +44 (0)1420 89007 Fax: +44 (0)1420 87301 www.rg-racing.com Email: info@rg-racing.com



ISSUE 1 - 19/09/2024 (MH)

CONSUMER NOTICE

The catalogue description and any exhibition of samples are only broad indications of the Products and R&G may make design changes which do not diminish their performance or visual appeal and supplying them in such state shall conform to the order. The Buyer acknowledges no representation or warranty (other than as to title) has been given or will apply to the Products other than those in R&G's order or confirmation and the Buyer confirms it has chosen the Products as being of merchantable quality and suitable for its particular purposes. Where R&G fits the Products or undertakes other services it shall exercise reasonable skill and care and rectify any fault free of charge unless the workmanship has been disturbed. The Buyer is responsible for ensuring that the warranty on the motorcycle is not affected by the fitting of the Products. On return of any defective Products R&G shall at its option either supply a replacement or refund the purchase money but shall not be liable if the Products have been modified or used or maintained otherwise than in accordance with R&G's or manufacturer's instructions and good engineering practice or if the defect arises from accident or neglect. Other than identified above and subject to R&G not limiting its liability for causing death and personal injury, it shall not be liable for indirect or consequential loss and otherwise its liability shall be limited to the amounts paid by the Buyer for the Products or the fitting or service concerned. These terms do not affect the Buyer's statutory rights.

R&G RACING RETURNS POLICY (NON-FAULTY GOODS)

Returns must be pre-authorized (if not pre-authorized the return will be rejected). Goods may only be returned direct to us if they were purchased direct from us (customer must prove if necessary). Otherwise to be returned to original vendor. Goods must be in re-sellable condition, in the opinion of R&G Racing. All returns are subject to a 25% restocking and handling fee (25% of the gross value exc. P&P - at the prevailing price at time of purchase). The customer must pay any and all carriage charges. No returns of discontinued products, unless within 14 days of purchase. This policy does not affect your statutory rights and does not refer to faulty goods.

R&G Racing

Unit 1, Shelley's Lane, East Worldham, Alton, Hampshire, GU34 3AQ

Tel: +44 (0)1420 89007 Fax: +44 (0)1420 87301 www.rg-racing.com Email: info@rg-racing.com



NOTICE DE MONTAGE POUR RAD0360PRO

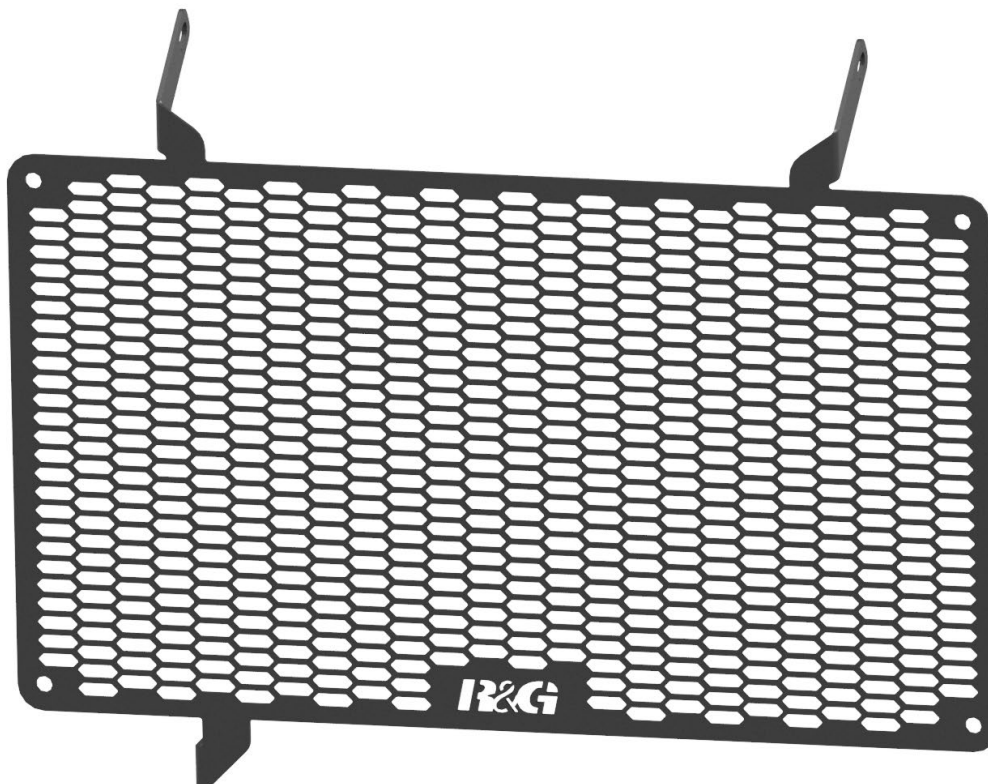

CE KIT CONTIENT LES ARTICLES ILLUSTRÉS ET ÉTIQUETES SUR LA PAGE.

CERTAINES PARTIES PEUVENT ÊTRE PRÉSENTES UNIQUEMENT POUR LA CLARTE DES INSTRUCTIONS.

NE PAS PROCÉDER AU MONTAGE TANT QUE VOUS N'ÊTES PAS SÛR QUE TOUTES LES PIÈCES SOIENT PRÉSENTES.

VEUILLEZ LIRE TOUTES LES INSTRUCTIONS AVANT DE CONTINUER.

EN CAS DE DOUTE LORS DU MONTAGE DE NOS PRODUITS, CONSULTEZ UN DE NOS REVENDEURS OU FAITES APPEL À UN TECHNICIEN QUALIFIÉ.

VEUILLEZ NOTER QUE LA FAÇON DONT LE KIT EST EMBALLÉ NE REPRÉSENTE PAS NECESSAIREMENT LA MANIÈRE DE LE MONTER SUR LA MOTO.

SI DES RONDELLES EN CAOUTCHOUC SONT UTILISÉES POUR MAINTENIR LES COMPOSANTS SUR LES BOULONS, ELLES PEUVENT ÊTRE JETÉES.

NOTICE DISPONIBLE AU TÉLÉCHARGEMENT SUR :

WWW.RG-RACING.COM

R&G Racing

Unit 1, Shelley's Lane, East Worldham, Alton, Hampshire, GU34 3AQ

Tel: +44 (0)1420 89007 Fax: +44 (0)1420 87301 www.rg-racing.com Email: info@rg-racing.com



<u>OUTILS REQUIS</u>	<u>VALEURS DE SERRAGE</u>
<ul style="list-style-type: none"> CLÉ À MOLETTE 8mm & 10mm 	M4 BOULON = 8Nm M5 BOULON = 12Nm M6 BOULON = 15Nm M8 BOULON = 20Nm M10 BOULON = 40Nm M12 BOULON = 40Nm

LÉGENDE

ARTICLE NO.	DESCRIPTION	QTÉ
ARTICLE 1	RAD0360PRO (PROTECTION RADIATEUR EN ALU)	1
ARTICLE 2	RB0015 (OEILLET EN CAOUTCHOUC)	4

SCHÉMA DE MONTAGE

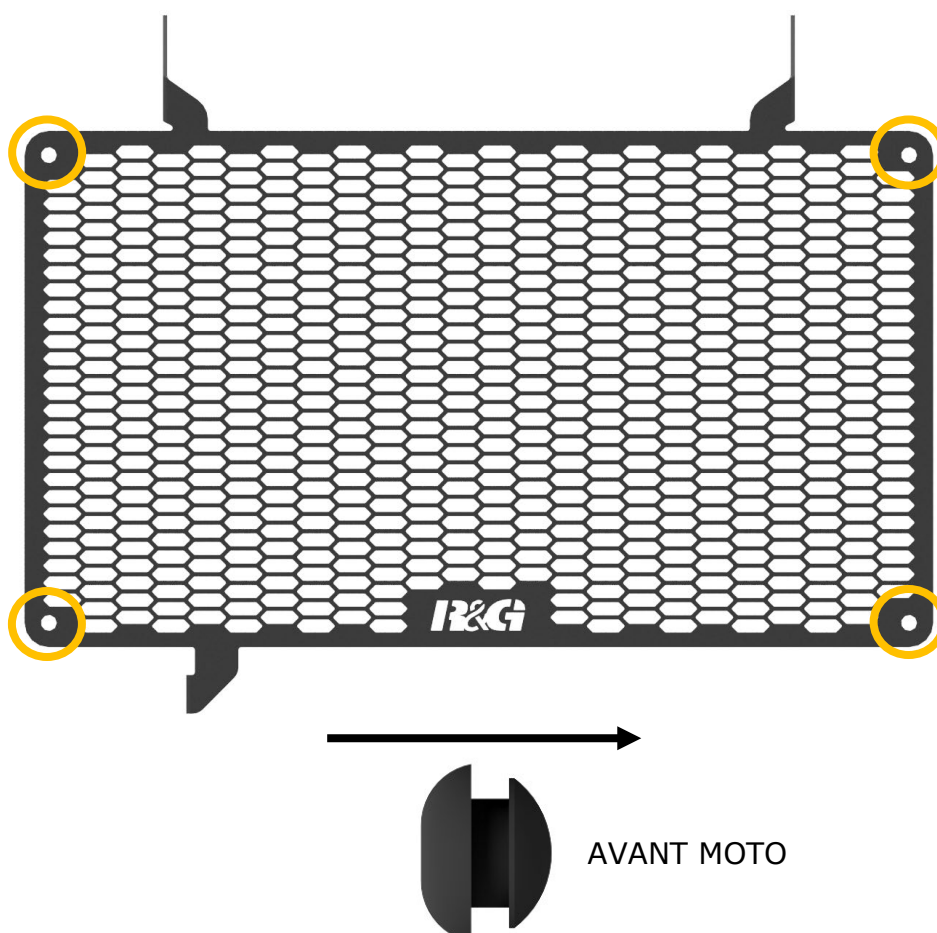

AVANT MOTO

R&G Racing

Unit 1, Shelley's Lane, East Worldham, Alton, Hampshire, GU34 3AQ

Tel: +44 (0)1420 89007 Fax: +44 (0)1420 87301 www.rg-racing.com Email: info@rg-racing.com



NOTICE DE MONTAGE

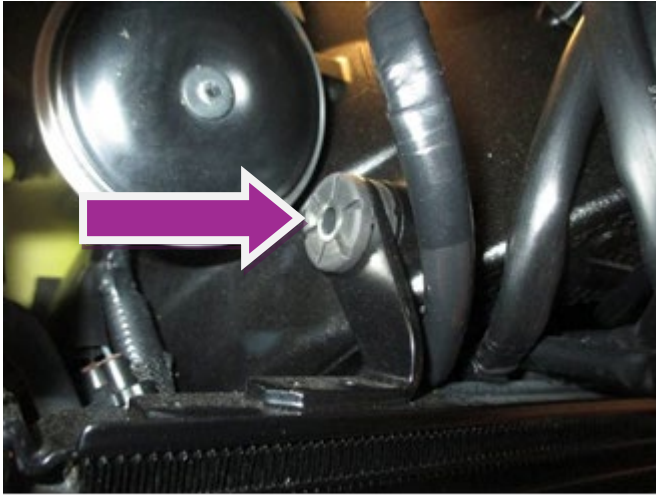

Photo 1

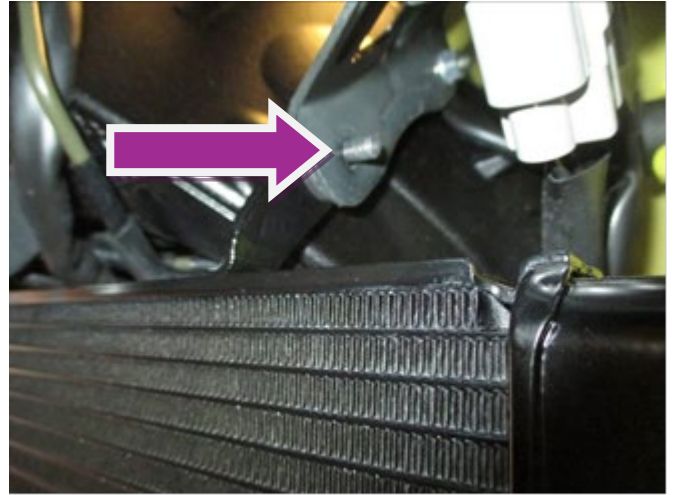

Photo 2

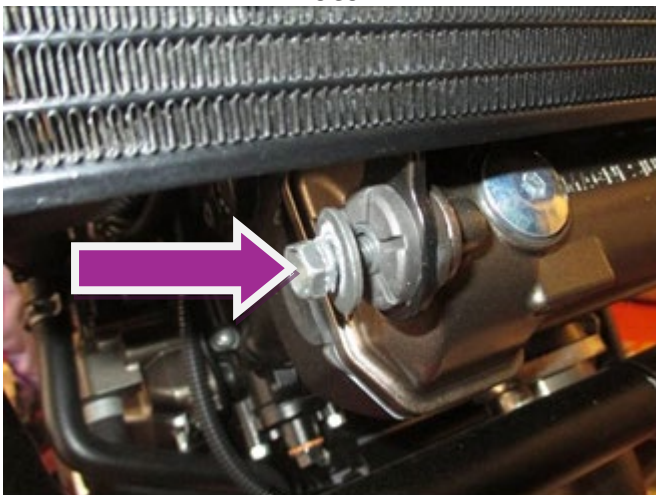

Photo 3

NOTICE DE MONTAGE

- Insérez les 4 œillets en caoutchouc (article 2) dans la protection radiateur dans les trous entourés en jaune (comme indiqué ci-dessus) s'ils ne sont pas déjà installés.
- Retirez le boulon de montage supérieur du radiateur comme indiqué sur la photo 1.
- Retirez l'écrou à l'extérieur du support du radiateur comme indiqué sur la photo 2.
- Placez la protection du radiateur (article 1) en position en vous assurant que le support côté gauche s'accroche sur le filetage de montage et que le support supérieur côté droit s'aligne avec le support du radiateur.
- Remplacez l'écrou du support de radiateur côté gauche.
- Remplacez le boulon retiré du support côté droit en vous assurant de le placer à travers le support de protection radiateur, ne serrez pas complètement à ce stade.
- Retirez le boulon de montage inférieur du radiateur comme indiqué sur la photo 3 et faites pivoter la protection radiateur en position, en alignant le trou de montage inférieur de la protection radiateur avec le support inférieur.
- Une fois que vous êtes satisfait de la position de la protection radiateur, serrez chaque boulon jusqu'à ce que la protection soit fermement fixée en position.

R&G Racing

Unit 1, Shelley's Lane, East Worldham, Alton, Hampshire, GU34 3AQ

Tel: +44 (0)1420 89007 Fax: +44 (0)1420 87301 www.rg-racing.com Email: info@rg-racing.com



ISSUE 1 – 19/09/2024 (MH)

CONSUMER NOTICE

The catalogue description and any exhibition of samples are only broad indications of the Products and R&G may make design changes which do not diminish their performance or visual appeal and supplying them in such state shall conform to the order. The Buyer acknowledges no representation or warranty (other than as to title) has been given or will apply to the Products other than those in R&G's order or confirmation and the Buyer confirms it has chosen the Products as being of merchantable quality and suitable for its particular purposes. Where R&G fits the Products or undertakes other services it shall exercise reasonable skill and care and rectify any fault free of charge unless the workmanship has been disturbed. The Buyer is responsible for ensuring that the warranty on the motorcycle is not affected by the fitting of the Products. On return of any defective Products R&G shall at its option either supply a replacement or refund the purchase money but shall not be liable if the Products have been modified or used or maintained otherwise than in accordance with R&G's or manufacturer's instructions and good engineering practice or if the defect arises from accident or neglect. Other than identified above and subject to R&G not limiting its liability for causing death and personal injury, it shall not be liable for indirect or consequential loss and otherwise its liability shall be limited to the amounts paid by the Buyer for the Products or the fitting or service concerned. These terms do not affect the Buyer's statutory rights.

R&G RACING RETURNS POLICY (NON-FAULTY GOODS)

Returns must be pre-authorized (if not pre-authorized the return will be rejected). Goods may only be returned direct to us if they were purchased direct from us (customer must prove if necessary). Otherwise to be returned to original vendor. Goods must be in re-sellable condition, in the opinion of R&G Racing. All returns are subject to a 25% restocking and handling fee (25% of the gross value exc. P&P – at the prevailing price at time of purchase). The customer must pay any and all carriage charges. No returns of discontinued products, unless within 14 days of purchase. This policy does not affect your statutory rights and does not refer to faulty goods.

R&G Racing

Unit 1, Shelley's Lane, East Worldham, Alton, Hampshire, GU34 3AQ

Tel: +44 (0)1420 89007 Fax: +44 (0)1420 87301 www.rg-racing.com Email: info@rg-racing.com